

Wandcontactdoos

Bestelnr. 7241



- schroefklemmen
- afschakelbaar
- met mechanische DUO-vergrendeling
- 3-polige installatieautomaat K
- contactdozen zijn met een hangslot afsluitbaar

Technische informatie

Ampère	32 A
Polen	4 p
Voltage	400 V
Uurstand	6 h
Hertz	50-60 Hz
Aansluittechniek	schroefklemmen
Contacten	standaard
Beschermingsgraad	IP67
Behuizing materiaal	Kunststof
Gewicht	2310 g
Certificeringen	EAC

Tekeningen

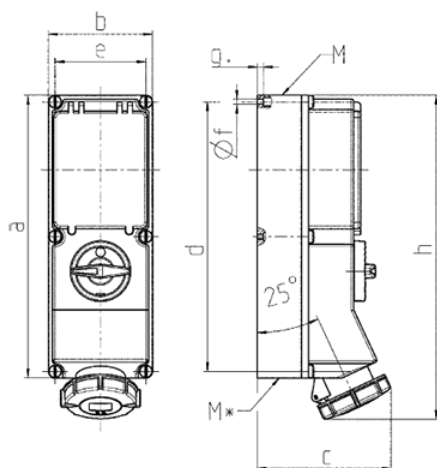

Tekening	Amp.	16			32		63	
		3	4	5	4	5	4	5
1 MB 181/620	Polen							
Maten in mm	a	364	364	364	364	364	460	460
	b	134	134	134	134	134	180	180
	c	160	162	163	168	168	202	202
	d	347	347	347	347	347	440	440
	e	117	117	117	117	117	160	160
	f	6,3	6,3	6,3	6,3	6,3	8,1	8,1
	g	8	8	8	8	8	8	8
	h	391	395	398	408	411	505	505
	M	32/40	32/40	32/40	32/40	32/40	40	40
	M*	2x32	2x32	2x32	2x32	2x32	2x40	2x40
Kabel Ø tot mm		27	27	27	27	27	27	27
Kabelaansluiting van/tot mm ²		1,5	1,5	1,5	2,5	2,5	6	6
		-4	-4	-4	-10	-10	-25	-25