

Inbouwcontactdoos RAPIDO® CEEplus®

Bestelnr. 962

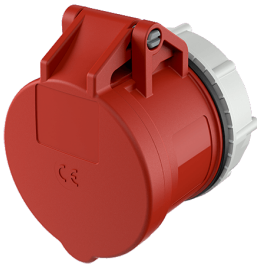

- schroefklemmen
- met 4 extra contacten
- rechte uitvoering
- centrale bevestiging Ø 61mm

Technische informatie

Ampère	16 A
Polen	5 p+e
Voltage	400 V
Uurstand	6 h
Hertz	50-60 Hz
Aansluittechniek	schroefklemmen
Contacten	standaard
Beschermingsgraad	IP 44
Gewicht	200 g
Certificeringen	EAC

Tekeningen

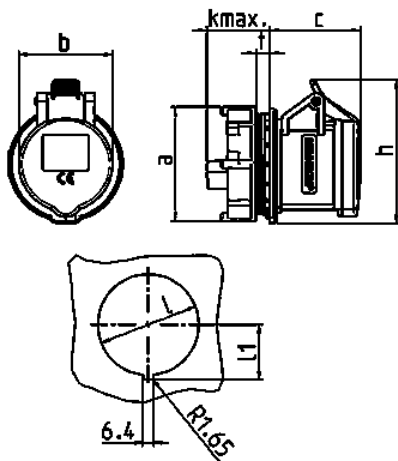

Tekening	Amp.	16	
		3	5
1 MB 458/468	Polen		
Maten in mm	a	69	69
	b	57	69
	c	55	52
	d	38	32
	h	87	98
	k max.	30	32
	l	Ø61	Ø61
	l1	33,25	33,25
	t	2-9	2-9
Kabelaansluiting		1,5	1,5
van/tot mm²		—4	—4