

RAPIDO toestelcontactstop

Bestelnr. 933



- met schroefklemmen
- voor boorgat van 70 mm Ø
- centrale bevestiging

Technische informatie

Ampère	16 A
Polen	4 p
Voltage	400 V
Uurstand	6 h
Hertz	50-60 Hz
Aansluittechniek	schroefklemmen
Contacten	standaard
Beschermingsgraad	IP 44
Gewicht	145 g
Certificeringen	VDE (ÜG)

Tekeningen

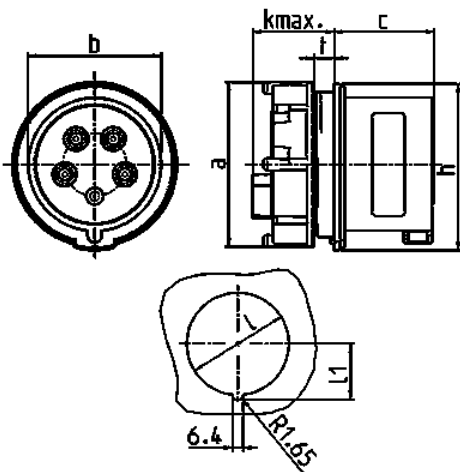

Tekening	Amp. Polen	16		32		
		4	5	3	4	5
2 MB 215						
Maten in mm	a	78	78	78	78	78
	b	50	56	58	58	64
	c	45	44	51	51	51
	k max.	33	33	33	33	33
	h	82	82	82	82	82
	l	70	70	70	70	70
	lt	37,75	37,75	37,75	37,75	37,75
	t	wanddikte 2-9mm		wanddikte 2-9mm		
Kabelaansluiting		1,5	1,5	2,5	2,5	2,5
van/tot mm²		—4	—4	—10	—10	—10