

Inbouwcontactdoos

Bestelnr. 808A



- schroefklemmen
- rechte uitvoering

Technische informatie

Ampère	32 A
Polen	3 p
Voltage	na scheidingstransformator
Uurstand	12 h
Aansluittechniek	schroefklemmen
Contacten	standaard
Beschermingsgraad	IP 67
Flens	85x75 mm
Bevestigingsgaten	60x60 mm
Gewicht	236 g
Certificeringen	EAC, CQC

Tekeningen

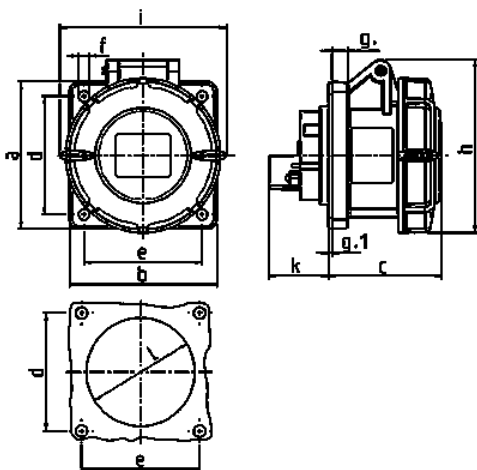

Tekening 1 MB 141	Amp. Polen	16			32		
		3	4	5	3	4	5
Maten in mm	a	75	75	75	85	85	85
	b	75	75	75	75	75	75
	c	60	61	61	70	70	72
	d	60	60	60	60	60	60
	e	60	60	60	60	60	60
	f	5,5	5,5	5,5	5,5	5,5	5,5
	g	8	8	8	8	8	8
	g.1	2	2	2	2	2	2
	h	83	88	95	99	99	105
	i	78	85	96	103	103	110
	k	31	32	32	39	39	39
	l	43	52	54	58	58	65
Kabelaansluiting van/tot mm²		1,5	1,5	1,5	2,5	2,5	2,5
		-4	-4	-4	-10	-10	-10