

Toestelcontactstop

Bestelnr. 75336



- 15° inclination
- seawater resistant design are available on request

Technische informatie

Ampère	400 A
Polen	5 p
Voltage	400 V
Uurstand	6 h
Hertz	50-60 Hz
Aansluittechniek	schroefklemmen
Contacten	standaard
Beschermingsgraad	IP 67
Gewicht	9300 g

Tekeningen

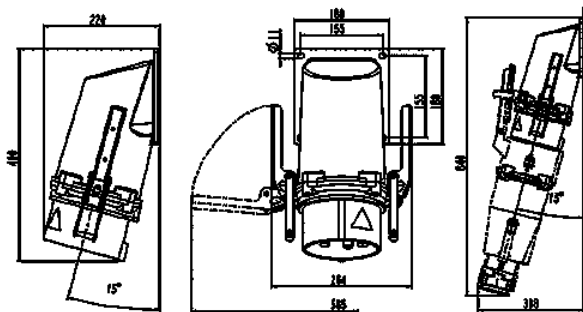

Tekening
2 MB 248

Maten in mm