

Toestelcontactstop

Bestelnr. 75331



- 15° inclination
- seawater resistant design are available on request

Technische informatie

Ampère	400 A
Polen	4 p
Voltage	400 V
Uurstand	6 h
Hertz	50-60 Hz
Aansluittechniek	schroefklemmen
Contacten	standaard
Beschermingsgraad	IP 67
Gewicht	8000 g

Tekeningen

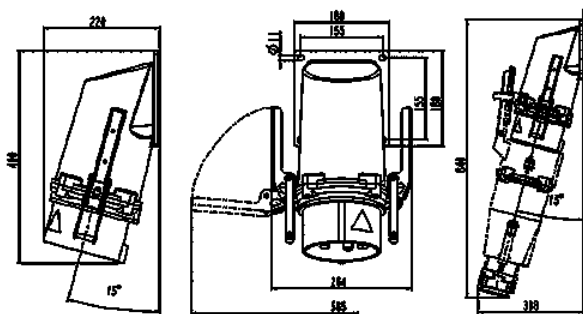

Tekening
2 MB 248

Maten in mm