

Wandcontactdoos

Bestelnr. 7006



- schroefklemmen
- **X-CONTACT®**
- met automatenrail, naar keuze achteraf uit te voeren met Neozed, Diazed, installatieautomaat en aardlekschakelaar

Technische informatie

Ampère	16 A
Polen	3 p
Voltage	110 V
Uurstand	4 h
Hertz	50-60 Hz
Aansluittechniek	schroefklemmen
Contacten	standaard
Beschermingsgraad	IP 44
Behuizing materiaal	Kunststof
Gewicht	452 g
Certificeringen	EAC

Tekeningen

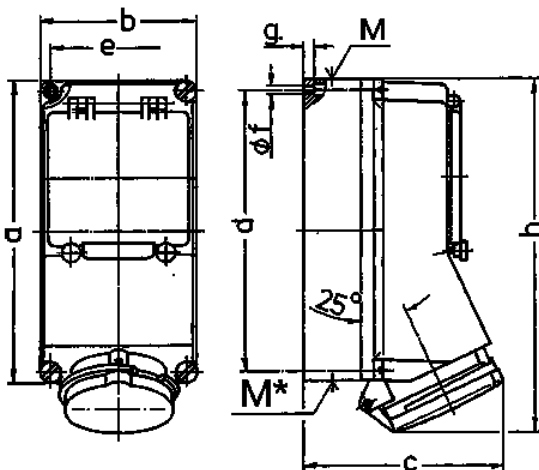

Tekening 1 MB 168	Amp. Polen	16			32		
		3	4	5	3	4	5
Maten in mm	a	225	225	225	225	225	225
	b	118	118	118	118	118	118
	c	141	141	141	146	146	146
	d	208	208	208	208	208	208
	e	101	101	101	101	101	101
	f	6,3	6,3	6,3	6,3	6,3	6,3
	g	8	8	8	8	8	8
	h	250	252	254	264	264	264
	M	1x25 en 1x32			1x25 en 1x32		
	M*	2x25	2x25	2x25	2x25	2x25	2x25
Kabel Ø tot mm		25	25	25	25	25	25
Kabelaansluiting van/tot mm²		1,5	1,5	1,5	2,5	2,5	2,5
		-4	-4	-4	-10	-10	-10