

Contactstop
Bestelnr. 637A



- schroefklemmen met tule

Technische informatie

Ampère	16 A
Polen	3 p
Voltage	40-50 V
Uurstand	12 h
Hertz	50-60 Hz
Aansluittechniek	schroefklemmen
Contacten	standaard
Beschermingsgraad	IP 44
Gewicht	153 g
Certificeringen	EAC, CQC

Tekeningen

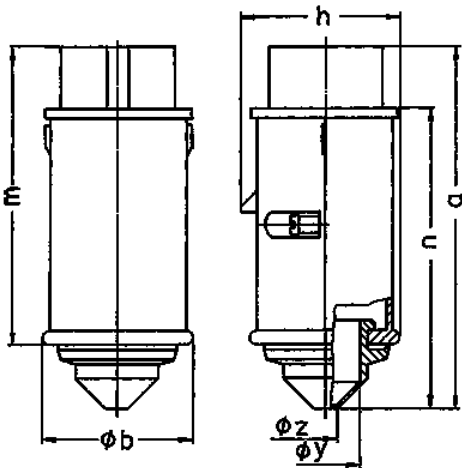

Tekening 2 MB 159	Amp. Polen	16		32	
		2	3	2	3
Maten in mm	a	130	130	130	130
	b	55	55	55	55
	h	58	58	58	58
	m	108	108	108	108
	n	107	107	107	107
	y	25	25	25	25
	z	9	9	9	9
	Kabelaansluiting van/tot mm ²		4	4	4
		-10	-10	-10	-10