

Koppelcontactstop AM-TOP

Bestelnr. 5



- ééndelige behuizing
- wartel met afdichting
- trekontlasting en knikbescherming

Technische informatie

Ampère	16 A
Polen	5 p
Voltage	400 V
Uurstand	6 h
Hertz	50-60 Hz
Aansluittechniek	schroefklemmen
Contacten	standaard
Beschermingsgraad	IP 44
Gewicht	222 g
Certificeringen	VDE, EAC, CQC

Tekeningen

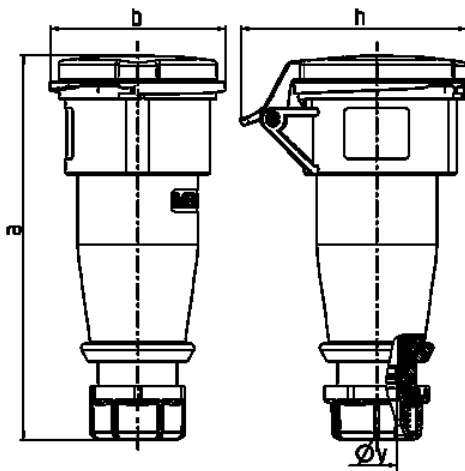

Tekening 3 MB 63	Amp. Polen	16			32		
		3	4	5	3	4	5
Maten in mm	a	162	165	167	209	209	208
	b	60	68	76	82	82	89
	h	83	92	98	100	100	108
	y	14,5	16	16	22	22	22
Kabelaansluiting		1	1	1	2,5	2,5	2,5
van/tot mm ²		-2,5	-2,5	-2,5	-6	-6	-6