

## Wandcontactdoos

Bestelnr. 5633A



- schroefklemmen
- **X-CONTACT®**
- afschakelbaar
- met mechanische DUO-vergrendeling
- automatenrail
- contactdozen zijn met een hangslot afsluitbaar

## Technische informatie

Ampère	16 A
Polen	5 p
Voltage	400 V
Uurstand	6 h
Hertz	50-60 Hz
Aansluittechniek	schroefklemmen
Contacten	standaard
Beschermingsgraad	IP 67
Behuizing materiaal	Kunststof
Gewicht	1940 g
Certificeringen	EAC, CQC

## Tekeningen

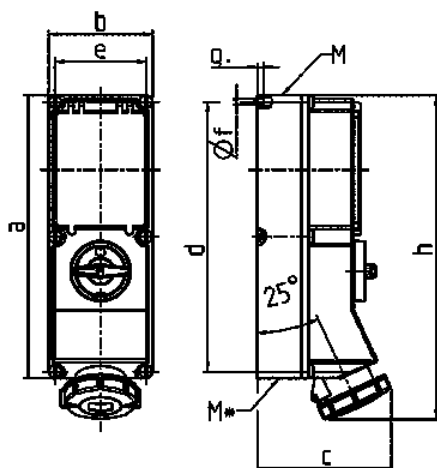

Tekening	Amp.	16			32		63	
		3	4	5	4	5	4	5
<b>1 MB 181/620</b>	<b>Polen</b>							
<b>Maten in mm</b>	<b>a</b>	364	364	364	364	364	460	460
	<b>b</b>	134	134	134	134	134	180	180
	<b>c</b>	160	162	163	168	168	202	202
	<b>d</b>	347	347	347	347	347	440	440
	<b>e</b>	117	117	117	117	117	160	160
	<b>f</b>	6,3	6,3	6,3	6,3	6,3	8,1	8,1
	<b>g</b>	8	8	8	8	8	8	8
	<b>h</b>	391	395	398	408	411	505	505
	<b>M</b>	32/40	32/40	32/40	32/40	32/40	40	40
	<b>M*</b>	2x32	2x32	2x32	2x32	2x32	2x40	2x40
	<b>Kabel Ø tot mm</b>	27	27	27	27	27	27	27
	<b>Kabelaansluiting van/tot mm²</b>	1,5	1,5	1,5	2,5	2,5	6	6
		-4	-4	-4	-10	-10	-25	-25