

Wandcontactdoos

Bestelnr. 5512



- schroefklemmen
- geschikt voor doorlussen
- met mogelijkheid voor klemmenstrook bestelnr. 40113

Technische informatie

Ampère	16 A
Polen	4 p
Voltage	500 V
Uurstand	7 h
Hertz	50-60 Hz
Aansluittechniek	schroefklemmen
Contacten	standaard
Beschermingsgraad	IP 67
Gewicht	728 g
Certificeringen	EAC, CQC

Tekeningen

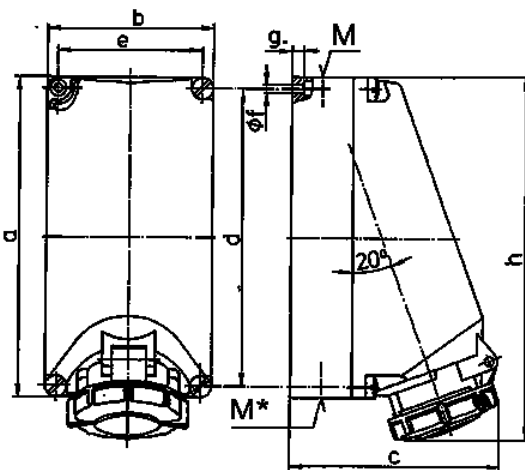

Tekening 1 MB 206	Amp. Polen	16			32		
		3	4	5	3	4	5
Maten in mm	a	225	225	225	225	225	225
	b	118	118	118	118	118	118
	c	144	150	152	155	155	159
	d	208	208	208	208	208	208
	e	101	101	101	101	101	101
	f	6,3	6,3	6,3	6,3	6,3	6,3
	g.	8	8	8	8	8	8
	h	249	251	253	255	253	259
	M	1x25 en 1x32			1x25 en 1x32		
	M*	2x25	2x25	2x25	2x25	2x25	2x25
Kabel Ø tot mm		25	25	25	25	25	25
Kabelaansluiting van/tot mm ²		1,5	1,5	1,5	2,5	2,5	2,5
		-4	-4	-4	-10	-10	-10