

## Wandcontactdoos

Bestelnr. 5004



- schroefklemmen
- 3-polige zekeringhouder D 01 resp. D 02

## Technische informatie

Ampère	16 A
Polen	5 p
Voltage	400 V
Uurstand	6 h
Hertz	50-60 Hz
Aansluittechniek	schroefklemmen
Contacten	standaard
Beschermingsgraad	IP 44
Behuizing materiaal	Kunststof
Gewicht	1030 g

## Tekeningen

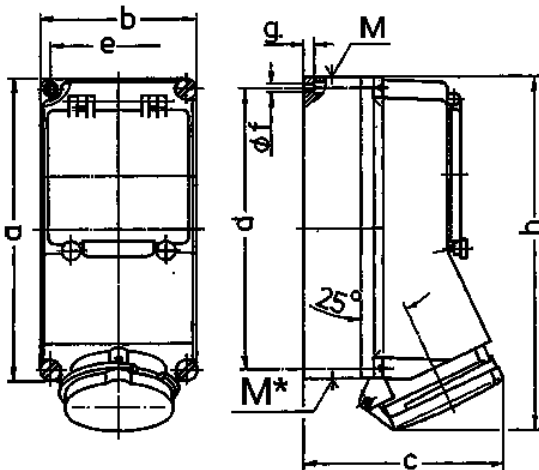

Tekening 1 MB 168	Amp. Polen	16			32		
		3	4	5	3	4	5
<b>Maten in mm</b>							
a		225	225	225	225	225	225
b		118	118	118	118	118	118
c		141	141	141	146	146	146
d		208	208	208	208	208	208
e		101	101	101	101	101	101
f		6,3	6,3	6,3	6,3	6,3	6,3
g		8	8	8	8	8	8
h		250	252	254	264	264	264
M		1x25 en 1x32			1x25 en 1x32		
M*		2x25	2x25	2x25	2x25	2x25	2x25
Kabel Ø tot mm		25	25	25	25	25	25
Kabelaansluiting van/tot mm <sup>2</sup>		1,5	1,5	1,5	2,5	2,5	2,5
		-4	-4	-4	-10	-10	-10