

## Cepex-inbouwcontactdoos, alpine wit

Bestelnr. 4273



- schroefklemmen
- met tekstvenster
- tevens geschikt voor wandgoot en energiezuilen

### Technische informatie

Ampère	16 A
Polen	4 p
Voltage	400 V
Uurstand	6 h
Hertz	50-60 Hz
Beschermingsgraad	IP 44
Aanrakingsveiligheid	false
Gewicht	181 g
Certificeringen	EAC

### Tekeningen

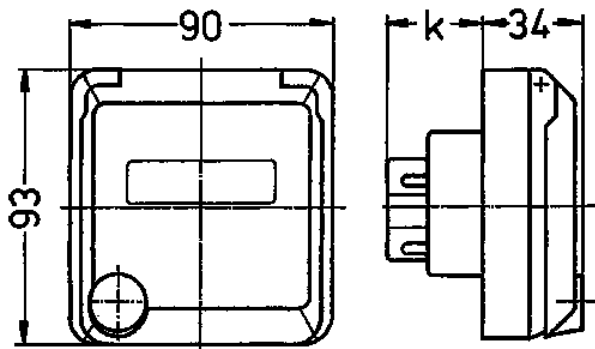

Tekening	Amp.	16			32		
		3	4	5	3	4	5
<b>1 MB 318</b>	<b>Polen</b>						
<b>Maten in mm</b>	<b>k</b>	32	32	32	48	48	48
<b>Kabelaansluiting</b>		1,5	1,5	1,5	2,5	2,5	2,5
<b>van/tot mm<sup>2</sup></b>		—4	—4	—4	—6	—6	—6