

Contactstop PowerTOP®

Bestelnr. 3918



- schroefklemmen
- hittebestendig binnenwerk
- vernikkelde contacten
- wartel en buitenliggende trekontlasting

Technische informatie

Ampère	16 A
Polen	3 p
Voltage	110 V
Uurstand	4 h
Hertz	50-60 Hz
Aansluittechniek	schroefklemmen
Contacten	hittebestendig binnenwerk, vernikkelde contacten
Beschermingsgraad	IP 44
Gewicht	176 g
Certificeringen	EAC

Tekeningen

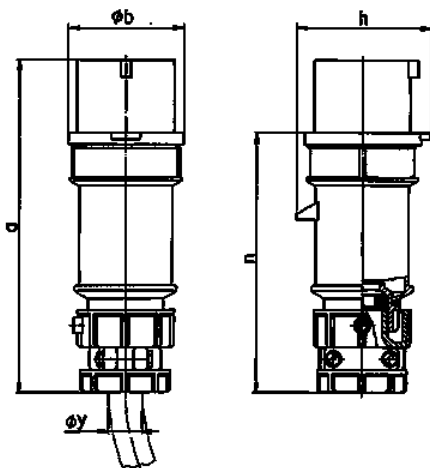

Tekening	Amp. Polen	16			32		
		3	4	5	3	4	5
Maten in mm	a	162	172	186	199	199	213
	b	54	60	69	72	72	79
	h	60	67	77	83	83	91
	n	126	136	149	154	154	169
	y	19	19	22	24,5	24,5	28,5
Kabelaansluiting		1	1	1	2,5	2,5	2,5
van/tot mm²		-2,5	-2,5	-2,5	-6	-6	-6