

Contactstop PowerTOP®

Bestelnr. 3796

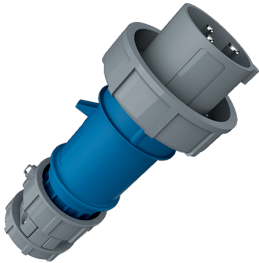

- schroefklemmen
- hittebestendig binnenwerk
- vernikkelde contacten
- wartel en buitenliggende trekontlasting

Technische informatie

Ampère	16 A
Polen	3 p
Voltage	230 V
Uurstand	6 h
Hertz	50-60 Hz
Aansluittechniek	schroefklemmen
Contacten	hittebestendig binnenwerk, vernikkelde contacten
Beschermingsgraad	IP 67
Gewicht	191 g
Certificeringen	VDE, EAC, CQC

Tekeningen

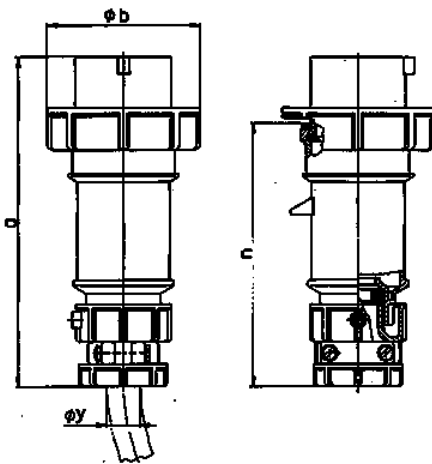

Tekening 2 MB 171	Amp. Polen	16			32		
		3	4	5	3	4	5
Maten in mm	a	162	172	186	199	199	213
	b	71	79	89	95	95	102
	n	129	139	152	157	157	172
	y	19	19	22	24,5	24,5	28,5
Kabelaansluiting		1	1	1	2,5	2,5	2,5
van/tot mm²		-2,5	-2,5	-2,5	-6	-6	-6