

Inbouwcontactdoos TwinCONTACT

Bestelnr. 3155



- schroefloos met insteekklemmen
- uniforme flensmaat
- 20° hoek
- contactdozen voorbereid op het aansluiten van een hulpcontact

Technische informatie

Ampère	32 A
Polen	4 p
Voltage	400 V
Uurstand	6 h
Hertz	50-60 Hz
Aansluittechniek	zonder schroeven, TwinCONTACT
Contacten	standaard
Beschermingsgraad	IP 44
Flens	85x85 mm
Bevestigingsgaten	70x70 mm
Hoek	20 °
Gewicht	224 g
Certificeringen	EAC

Tekeningen

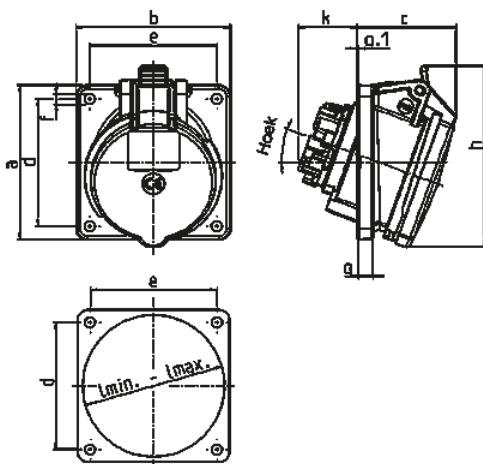

Tekening	Amp.	16			32		
		3	4	5	3	4	5
1 MB 519	Polen						
Maten in mm	a	85	85	85	85	85	85
	b	85	85	85	85	85	85
	c	52	57	55	61	60	66
	d	70	70	70	70	70	70
	e	70	70	70	70	70	70
	f	5,5	5,5	5,5	5,5	5,5	5,5
	g	8	8	8	8	8	8
	g.1	2	2	2	2	2	2
	h	86	96	100	96	104	110
	k	31	32	33	43	44	48
	l min.	57	64	70	78	78	78
	l max.	76	76	76	78	78	78
	∅	20	20	20	20	20	20
Kabelaansluiting		1,5	1,5	1,5	2,5	2,5	2,5
van/tot mm²		-4	-4	-4	-10	-10	-10