

## Inbouwcontactdoos

Bestelnr. 3072



- schroefklemmen
- met uniforme flensmaat
- 20° hoek
- contactdozen voorbereid op het aansluiten van een hulpcontact

## Technische informatie

Ampère	16 A
Polen	4 p
Voltage	400 V
Uurstand	6 h
Hertz	50-60 Hz
Aansluittechniek	schroefklemmen
Contacten	standaard
Beschermingsgraad	IP 44
Flens	85x85 mm
Bevestigingsgaten	70x70 mm
Hoek	20 °
Gewicht	166 g
Certificeringen	VDE, EAC, CQC

## Tekeningen

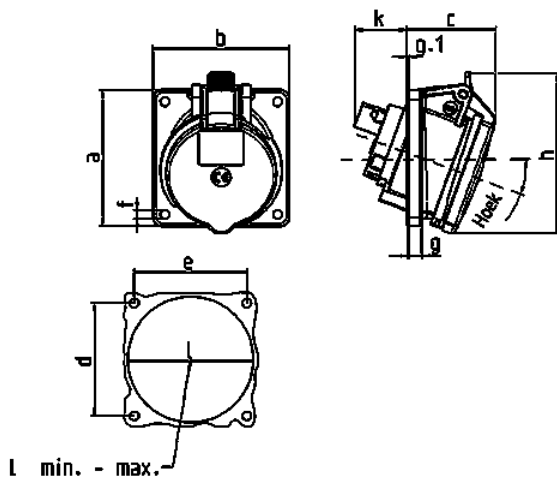

Tekening	Amp.	16			32		
		3	4	5	3	4	5
<b>1 MB 453</b>	<b>Polen</b>						
<b>Maten in mm</b>	<b>a</b>	85	85	85	85	85	85
	<b>b</b>	85	85	85	85	85	85
	<b>c</b>	53	57	57	60	60	67
	<b>d</b>	70	70	70	70	70	70
	<b>e</b>	70	70	70	70	70	70
	<b>f</b>	5,5	5,5	5,5	5,5	5,5	5,5
	<b>g</b>	8	8	8	8	8	8
	<b>g.1</b>	2	2	2	2	2	2
	<b>h</b>	89	96	101	103	103	110
	<b>k</b>	39	34	33	53	53	41
	<b>l min.</b>	57	64	70	78	78	78
	<b>l max.</b>	78	78	78	78	78	78
<b>Kabelaansluiting van/tot mm<sup>2</sup></b>		1,5	1,5	1,5	2,5	2,5	2,5
		-4	-4	-4	-10	-10	-10