

## Contactstop TM

Bestelnr. 24760



- schroefklemmen
- hittebestendig binnenwerk
- vernikkelde contacten
- met afschermkap (Vorm CP)

## Technische informatie

Ampère	32 A
Polen	3 p
Voltage	230 V
Uurstand	6 h
Hertz	50-60 Hz
Aansluittechniek	schroefklemmen
Contacten	hittebestendig binnenwerk, vernikkelde contacten
Beschermingsgraad	IP 67
Gewicht	353 g
Certificeringen	VDE, EAC

## Tekeningen

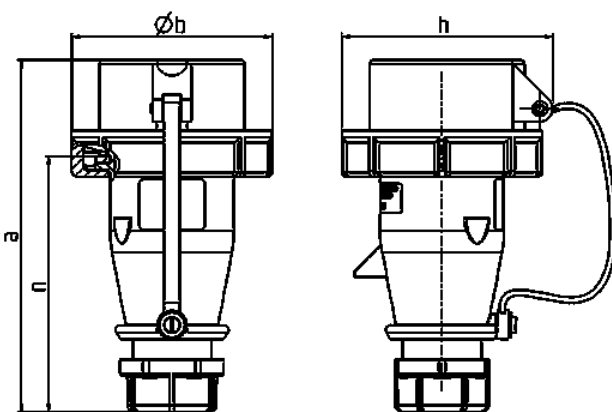

Tekening 2 MB 240	Amp. Polen	16		32	
		3	5	4	5
Maten in mm	a	148	153	191	185
	b	70	87	94	101
	h	75	92	97	105
	n	108	112	141	133
	y	14,5	16	22	22
Kabelaansluiting van/tot mm <sup>2</sup>		1	1	2,5	2,5
		-2,5	-2,5	-6	-6