

## Inbouwcontactdoos

Bestelnr. 234A



- rechte uitvoering

## Technische informatie

Ampère	32 A
Polen	4 p
Voltage	400 V
Uurstand	6 h
Hertz	50-60 Hz
Aansluittechniek	schroefklemmen
Contacten	standaard
Beschermingsgraad	IP 67
Flens	85x75 mm
Bevestigingsgaten	60x60 mm
Gewicht	293 g
Certificeringen	VDE, EAC, CQC

## Tekeningen

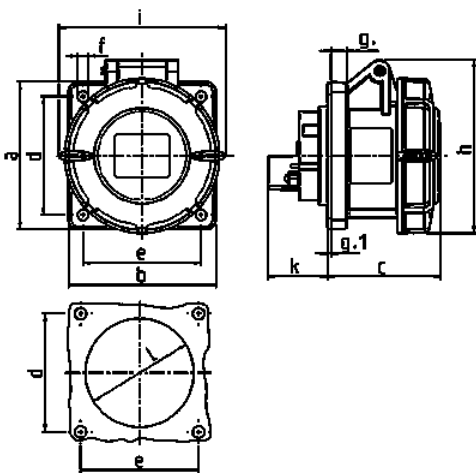

Tekening	Amp.	16			32		
		3	4	5	3	4	5
<b>1 MB 141</b>	<b>Polen</b>						
<b>Maten in mm</b>	<b>a</b>	75	75	75	85	85	85
	<b>b</b>	75	75	75	75	75	75
	<b>c</b>	60	61	61	70	70	72
	<b>d</b>	60	60	60	60	60	60
	<b>e</b>	60	60	60	60	60	60
	<b>f</b>	5,5	5,5	5,5	5,5	5,5	5,5
	<b>g.</b>	8	8	8	8	8	8
	<b>g.1</b>	2	2	2	2	2	2
	<b>h</b>	83	88	95	99	99	105
	<b>i</b>	78	85	96	103	103	110
	<b>k</b>	31	32	32	39	39	39
	<b>l</b>	43	52	54	58	58	65
<b>Kabelaansluiting</b>		1,5	1,5	1,5	2,5	2,5	2,5
<b>van/tot mm²</b>		-4	-4	-4	-10	-10	-10