

## Contactstop AM-TOP®

Bestelnr. 22289

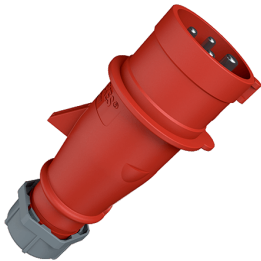

- schroefklemmen
- ééndelige behuizing
- hittebestendig binnenwerk
- vernikkelde contacten
- wartel met afdichting
- trekontlasting met knikbescherming

## Technische informatie

Ampère	16 A
Polen	4 p
Voltage	400 V
Uurstand	6 h
Hertz	50-60 Hz
Aansluittechniek	schroefklemmen
Contacten	vernikkelde contacten, hittebestendig binnenwerk
Beschermingsgraad	IP 44
Gewicht	153 g
Certificeringen	VDE, EAC, CQC

## Tekeningen

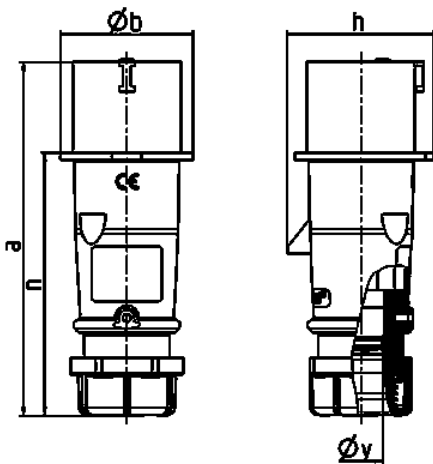

Tekening	Amp. Polen	16			32		
		3	4	5	3	4	5
<b>Maten in mm</b>	<b>a</b>	142	147	147	186	186	180
	<b>b</b>	53	59	67	70	70	77
	<b>h</b>	59	69,4	76	81	81	89,5
	<b>n</b>	105	110	110	141	141	135
	<b>y</b>	14,5	16	16	22	22	22
<b>Kabelaansluiting</b>		1	1	1	2,5	2,5	2,5
<b>van/tot mm²</b>		-2,5	-2,5	-2,5	-6	-6	-6