

## Koppelcontactstop AM-TOP®

Bestelnr. 21039



- schroefklemmen
- ééndelige behuizing
- hittebestendig binnenwerk
- vernikkelde contacten
- wartel met afdichting
- trekontlasting en knikbescherming

### Technische informatie

Ampère	32 A
Polen	5 p
Voltage	400 V
Uurstand	6 h
Hertz	50-60 Hz
Aansluittechniek	schroefklemmen
Contacten	hittebestendig binnenwerk, vernikkelde contacten
Beschermingsgraad	IP 44
Gewicht	389 g
Certificeringen	VDE, EAC, CQC

### Tekeningen

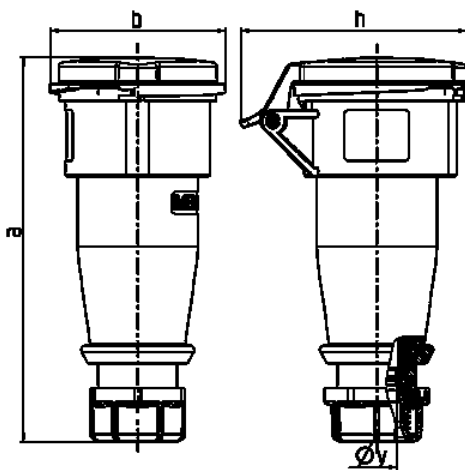

Tekening	Amp. Polen	16			32		
		3	4	5	3	4	5
<b>Maten in mm</b>	<b>a</b>	162	165	167	209	209	208
	<b>b</b>	60	68	76	82	82	89
	<b>h</b>	83	92	98	100	100	108
	<b>y</b>	14,5	16	16	22	22	22
<b>Kabelaansluiting</b>		1	1	1	2,5	2,5	2,5
<b>van/tot mm²</b>		-2,5	-2,5	-2,5	-6	-6	-6