

## Inbouwcontactdoos

Bestelnr. 205P



- schroefklemmen
- X-CONTACT®
- 20° hoek 63 A
- 15° hoek 125 A
- product met lange bussen en pilootcontactbus

## Technische informatie

Ampère	63 A
Polen	4 p
Voltage	400 V
Uurstand	6 h
Hertz	50-60 Hz
Aansluittechniek	schroefklemmen
Contacten	X-CONTACT®
Beschermingsgraad	IP 67
Flens	110x106 mm
Bevestigingsgaten	85x77 mm
Hoek	20 °
Gewicht	615 g
Certificeringen	VDE

## Tekeningen

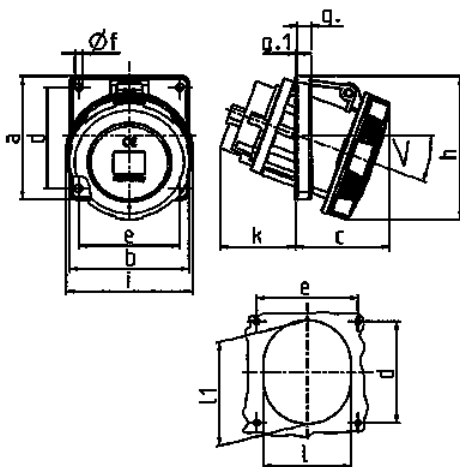

1 MB 298 1 MB 601	Amp. Polen	63			125		
		3	4	5	3	4	5
<b>Maten in mm</b>							
a		110	110	110	114	114	114
b		106	106	106	110	110	110
c		85	85	85	75	75	75
d		85	85	85	90	90	90
e		77	77	77	90	90	90
f		6,2	6,2	6,2	6,2	6,2	6,2
g.		12	12	12	13	13	13
g.1		2	2	2	2	2	2
h		128	128	128	133	133	133
i		113	113	113	126	126	126
k		67	67	67	103	103	103
l		92	92	92	94	94	94
h		98	98	98	107	107	107
<		20°	20°	20°	15°	15°	15°
<b>Kabelaansluiting van/tot mm²</b>							
		6	6	6	25	25	25
		-25	-25	-25	70	70	70