

## Wandcontactdoos

Bestelnr. 20162A



- schroefklemmen
- hittebestendig binnenwerk
- vernikkelde contacten
- binnenliggende bevestiging
- behuizing 180° draaibaar

## Technische informatie

Ampère	32 A
Polen	5 p
Voltage	400 V
Uurstand	6 h
Hertz	50-60 Hz
Aansluittechniek	schroefklemmen
Contacten	hittebestendig binnenwerk, vernikkelde contacten
Beschermingsgraad	IP 44
Gewicht	424 g
Certificeringen	EAC

## Tekeningen

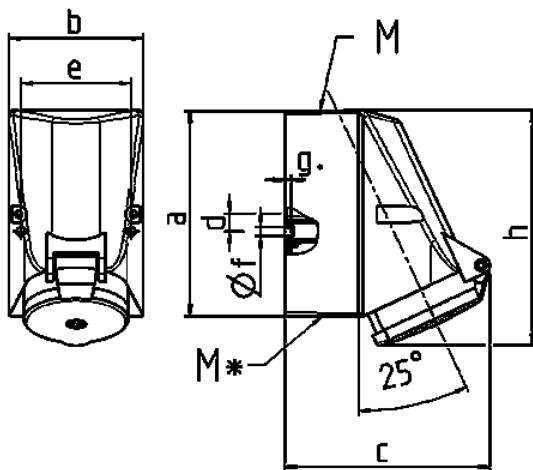

1 MB 209 1 MB 43	Amp. Polen	16			32		
		3	4	5	3	4	5
<b>Maten in mm</b>	<b>a</b>	87	128	128	128	128	128
	<b>b</b>	64	84	84	84	84	84
	<b>c</b>	99	122	124	136	136	138
	<b>d</b>	40	11	11	11	11	11
	<b>e</b>	50	68	68	68	68	68
	<b>f</b>	4,5	5,3	5,3	5,3	5,3	5,3
	<b>g</b>	4	4	4	4	4	4
	<b>h</b>	115	144	145	158	158	160
	<b>M</b>	20	25	25	32	32	32
	<b>M*</b>	20 2x25 (blind) breekpoort			2x25 (blind) breekpoort		
<b>Kabel Ø tot mm</b>		15	18	18	18/25	18/25	18/25
<b>Kabelaansluiting van/tot mm²</b>		1,5	1,5	1,5	2,5	2,5	2,5
		-4	-4	-4	-10	-10	-10