

Inbouwcontactdoos TwinCONTACT

Bestelnr. 1679



- schroefloos met insteekklemmen
- geschikt voor doorlussen
- rechte uitvoering
- blinddeksel om niet gebruikte opening af te sluiten: bestelnr. 41419

Technische informatie

Ampère	16 A
Polen	5 p
Voltage	230 V
Uurstand	9 h
Hertz	50-60 Hz
Aansluittechniek	zonder schroeven, TwinCONTACT
Contacten	standaard
Beschermingsgraad	IP 44
Flens	75x75 mm
Bevestigingsgaten	60x60 mm
Gewicht	140 g
Certificeringen	VDE, EAC, CQC

Tekeningen

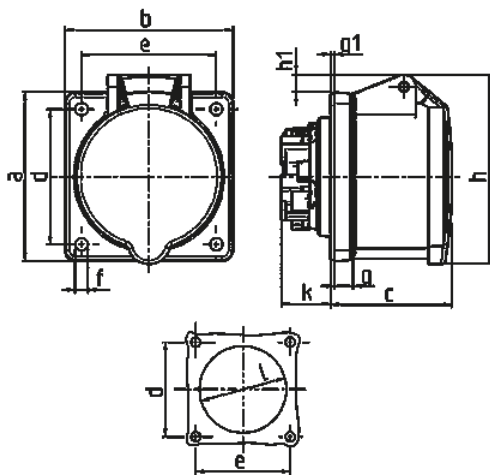

Tekening	Amp.	16			32		
		3	4	5	3	4	5
1 MB 464	Polen						
Maten in mm	a	75	75	75	75	75	75
	b	75	75	75	75	75	75
	c	53	53	54	64	64	64
	d	60	60	60	60	60	60
	e	60	60	60	60	60	60
	f	5,5	5,5	5,5	5,5	5,5	5,5
	g.	8	8	8	8	8	8
	g.1	2	2	2	2	2	2
	h	75	80	85	89	89	95
	h1		5	8	10	10	12
	k	22	22	22	28	28	28
	l	43	52	57	60	60	64
Kabelaansluiting		1,5	1,5	1,5	2,5	2,5	2,5
van/tot mm²		—4	—4	—4	—6	—6	—6