

Inbouwcontactdoos TwinCONTACT

Bestelnr. 156



- schroefloos met insteekklemmen
- geschikt voor doorlussen
- 20° hoek

Technische informatie

Ampère	16 A
Polen	5 p
Voltage	400 V
Uurstand	6 h
Hertz	50-60 Hz
Aansluittechniek	zonder schroeven, TwinCONTACT
Contacten	standaard
Beschermingsgraad	IP 44
Flens	87x71 mm
Bevestigingsgaten	70x52 mm
Hoek	20 °
Gewicht	140 g
Certificeringen	VDE, EAC

Tekeningen

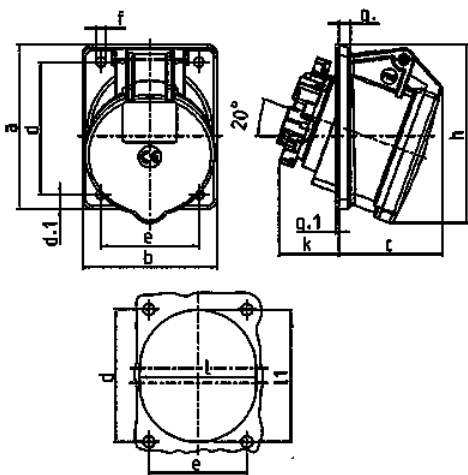

Tekening	Amp. Polen	16	
		4	5
1 MB 650			
Maten in mm			
a		87	87
b		71	71
c		58	57
d		70	70
d.1		7,5	7,5
e		52	52
f		5,1	5,1
g		6	6
g.1		2	2
h		92	95
k		31	32
l		61	62
ll		-	72
Kabelaansluiting			
van/tot mm²		1,5	1,5
		-4	-4