

Inbouwcontactdoos

Bestelnr. 1499



- schroefklemmen
- 20° hoek
- Contactdozen: Voorbereid op het aansluiten van een hulpcontact

Technische informatie

Ampère	32 A
Polen	5 p
Voltage	230 V
Uurstand	9 h
Hertz	50-60 Hz
Aansluittechniek	schroefklemmen
Contacten	standaard
Beschermingsgraad	IP 44
Flens	100x92 mm
Bevestigingsgaten	85x77 mm
Hoek	20 °
Gewicht	288 g
Certificeringen	EAC, CQC

Tekeningen

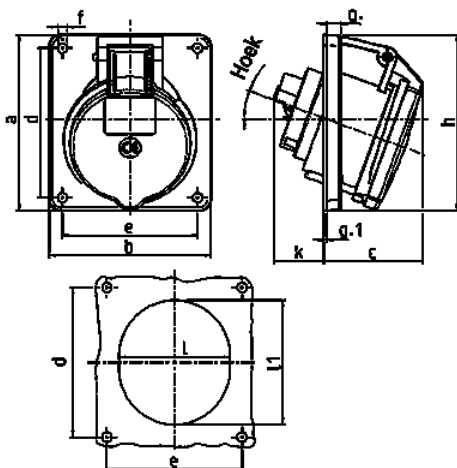

Tekening 1 MB 260	Amp. Polen	16			32		
		3	4	5	3	4	5
Maten in mm							
a		73,5	100	100	100	100	100
b		64	92	92	92	92	92
c		50	59	58	62	62	61
d		60	85	85	85	85	85
e		52	77	77	77	77	77
f		5,5	5,5	5,5	5,5	5,5	5,5
g		7	8	8	8	8	8
g.1		2	2	2	2	2	2
h		79	100	100	103	103	106
k		44	34	34	54	54	49
l		52	55	65	67	67	72
li		60	63	72	82	82	85
α		20°	20°	20°	20°	20°	20°
Kabelansluiting van/tot mm²							
		1,5	1,5	1,5	2,5	2,5	2,5
		-4	-4	-4	-10	-10	-10