

Wandcontactdoos

Bestelnr. 138



- schroefklemmen
- **X-CONTACT®**
- producten met lange bussen en pilootcontactbus op aanvraag

Technische informatie

Ampère	125 A
Polen	4 p
Voltage	230 V
Uurstand	9 h
Hertz	50-60 Hz
Aansluittechniek	schroefklemmen
Contacten	X-CONTACT®
Beschermingsgraad	IP 67
Gewicht	1974 g
Certificeringen	EAC, CQC

Tekeningen

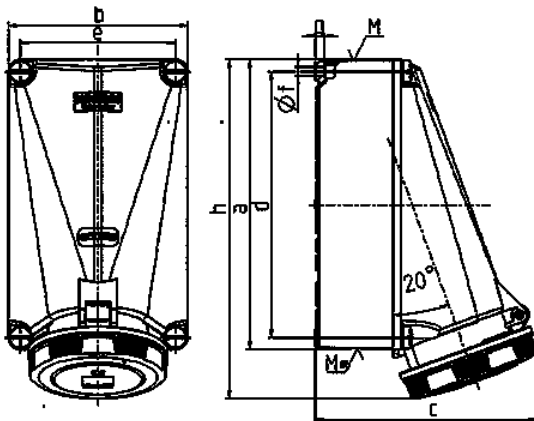

Tekening 1 MB 162	Amp. Polen	125	
		4	5
Maten in mm	a	264	264
	b	163	163
	c	200	200
	d	240	240
	e	140	140
	f	8,1	8,1
	g	8	8
	h	306	306
	M	50	50
	M*	50	50
Kabel Ø tot mm		38	38
Kabelaansluiting van/tot mm²		—35	—35