

Inbouwcontactdoos

Bestelnr. 1366



- schroefklemmen
- flens 75 x 75 mm
- h. o. h. maat bevestigingsgaten 60 x 60 mm
- rechte uitvoering

Technische informatie

Ampère	16 A
Polen	3 p
Voltage	230 V
Uurstand	6 h
Hertz	50-60 Hz
Aansluittechniek	schroefklemmen
Contacten	standaard
Beschermingsgraad	IP 44
Flens	75x75 mm
Bevestigingsgaten	60x60 mm
Gewicht	136 g
Certificeringen	VDE, EAC, Kema, CQC

Tekeningen

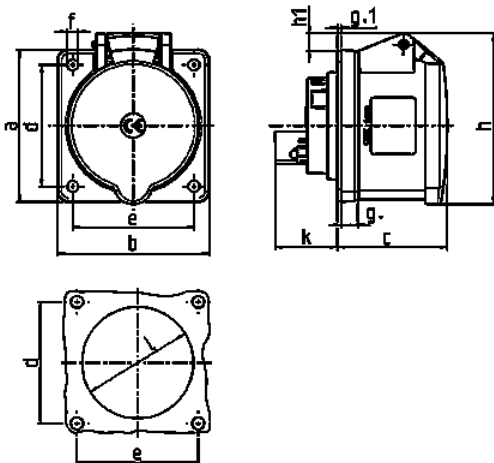

Tekening	Amp.	16			32		
		3	4	5	3	4	5
1 MB 247	Polen						
Maten in mm	a	75	75	75	75	75	75
	b	75	75	75	75	75	75
	c	53	53	55	64	64	65
	d	60	60	60	60	60	60
	e	60	60	60	60	60	60
	f	5,5	5,5	5,5	5,5	5,5	5,5
	g	8	8	8	8	8	8
	g.1	2	2	2	2	2	2
	h	75	80	83	89	89	100
	h1		6	8	11	11	12
	k	31	32	32	39	39	39
	l	43	52	54	58	58	62
Kabelaansluiting		1,5	1,5	1,5	2,5	2,5	2,5
van/tot mm²		-4	-4	-4	-10	-10	-10