

Inbouwcontactdoos TwinCONTACT

Bestelnr. 1337



- schroefloos met insteekklemmen
- geschikt voor doorlussen
- rechte uitvoering

Technische informatie

Ampère	16 A
Polen	3 p
Voltage	110 V
Uurstand	4 h
Hertz	50-60 Hz
Aansluittechniek	zonder schroeven, TwinCONTACT
Contacten	standaard
Beschermingsgraad	IP 44
Flens	62x62 mm
Bevestigingsgaten	47x47 mm
Gewicht	210 g
Certificeringen	VDE, EAC

Tekeningen

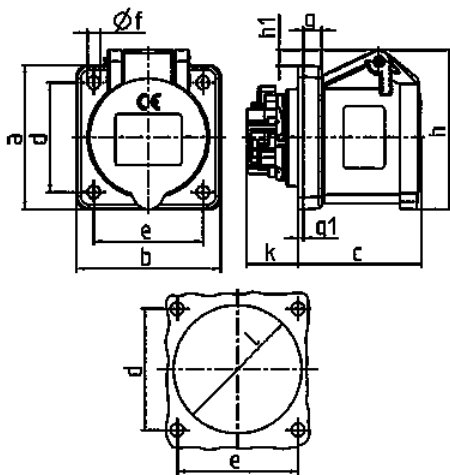

Tekening 1 MB 649	Amp. Polen	16		
		3	4	5
Maten in mm	a	62	72	72
	b	62	65	65
	c	54	54	54
	d	47	52	52
	e	47	52	52
	f	5,5	5,5	5,5
	g	8	8	8
	g1	2	2	2
	h	68	77	85
	h1	7	7	11
	k	23	23	23
l	50	52	57	
Kabelaansluiting van/tot mm ²		1,5	1,5	1,5
		—4	—4	—4