

Inbouwcontactdoos

Bestelnr. 1265A



- schroefklemmen
- X-CONTACT®
- rechte uitvoering
- producten met lange bussen en pilootcontactbus op aanvraag

Technische informatie

Ampère	63 A
Polen	3 p
Voltage	400 V
Uurstand	9 h
Hertz	50-60 Hz
Aansluittechniek	schroefklemmen
Contacten	X-CONTACT®
Beschermingsgraad	IP 44
Flens	107x100 mm
Bevestigingsgaten	85x77 mm
Gewicht	567 g
Certificeringen	VDE, EAC, CQC

Tekeningen

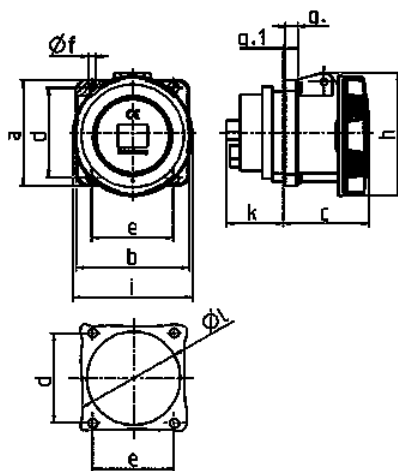

Tekening	Amp. Polen	63			125	
		3	4	5	4	5
1 MB 212/258						
Maten in mm						
a		107	107	107	130	130
b		100	100	100	130	130
c		81	81	81	119	119
d		85	85	85	104	104
e		77	77	77	104	104
f		6	6	6	6,5	6,5
g		12	12	12	18	18
g.1		2	2	2	2	2
h		117	117	117	129	129
i		113	113	113	126	126
k		55	55	55	43	43
l		88	88	88	95	95
Kabelaansluiting						
van/tot mm²		6	6	6	25	25
		-25	-25	-25	-70	-70