

Wandcontactdoos

Bestelnr. 102



- schroefklemmen
- binnenliggende bevestiging
- behuizing 180° draaibaar bij 4- en 5-polige uitvoering
- kabelinvoer 1 x boven en 1 x blind onder

Technische informatie

Ampère	16 A
Polen	3 p
Voltage	400 V
Uurstand	9 h
Hertz	50-60 Hz
Aansluittechniek	schroefklemmen
Contacten	standaard
Beschermingsgraad	IP 44
Gewicht	186 g
Certificeringen	VDE, EAC, CQC

Tekeningen

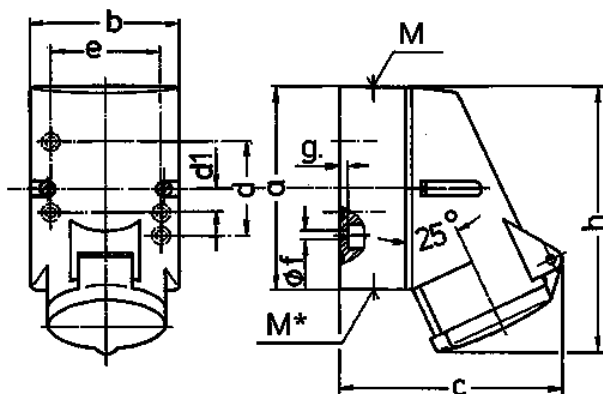

Tekening	Amp.	16		
		Polen		
1 MB 209		3	4	5
Maten in mm	a	87	100	100
	b	64	75	75
	c	99	110	113
	d	40	-	-
	d1	-	11	11
	e	50	59	59
	f	4,5	5	5
	g	4	4	4
	h	115	125	128
	M	20	20	20
	M*	20 (blind) breekpoort		
Kabel Ø tot mm		15	15	15
Kabelaansluiting van/tot mm²		1,5	1,5	1,5
		-4	-4	-4